

CONTENTS

3 STEM AND SHAFT SEALS

- 3 **General informations**
- 5 **Preformed graphite rings**
- 9 **Stuffing box sets**
- 13 **Distance bush**
- 14 **Braided packings for valves**

16 INTERNAL VALVES SEALS

- 16 **Ball valves seats**
- 18 **Butterfly seals**

19 BONNET SEALINGS

- 19 **Kammprofile, spiral wound gaskets, RTJ**
- 20 **Self-sealing graphite rings**

21 ACCESSORIES

22 GENERAL INFORMATIONS



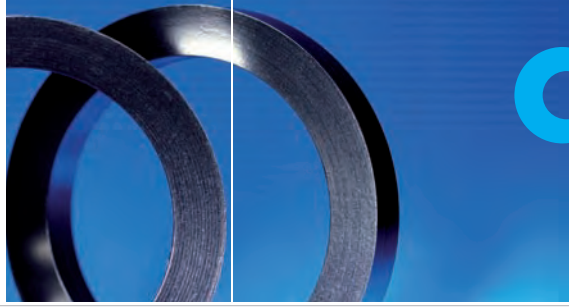

General informations

The SPETECH company uses, to manufacture GRAFMET® pre-formed graphite rings, only the highest-quality graphite foils made by SGL Carbon Group. This company, famous for development of graphite sealing, is at the present time the greatest and highly respectable supplier of graphite semi-products to manufacture various types of sealing. In particular, the types of foil, as specified beneath, are highly applicable to production of GRAFMET® rings.

Types of materials in GRAFMET®

GRAFMET® CODE	FOIL GRADE	DESCRIPTION
NO CODE	SIGRAFLEX® C	Standard Industrial Grade flexible graphite foil with $\geq 98,0\%$ carbon content, no binders or fillers, ash content $\leq 2\%$, total chloride content ≤ 25 ppm. Generally, if no special quality requirements are specified in an order, most of sealing products are made of this foil.
APX	SIGRAFLEX® APX	Special Oxidation Resistant Grade flexible graphite foil for maximum temperature resistance, ash content $\leq 2\%$, total chloride content ≤ 25 ppm. The material is recommended to be used in all applications where the temperature exceeds 450°C .
E	SIGRAFLEX® E	Premium Grade flexible graphite foil with $\geq 99,0\%$ carbon content with conventional inorganic passivating inhibitor for oxidation and corrosion resistance; no binders or fillers, ash content $\leq 1\%$, total chloride content ≤ 10 ppm.
N	SIGRAFLEX® Z	High Purity Nuclear Grade flexible graphite foil with $\geq 99,85\%$ carbon content, no binders or fillers, ash content $\leq 0,15\%$, total chloride content ≤ 10 ppm.
ZX	SIGRAFLEX® ZX	High Purity Nuclear Grade flexible graphite foil with strong corrosion inhibitor; total chloride content ≤ 10 ppm. The material is recommended to be used in systems with raw and/or polluted water, because it minimizes the phenomenon of galvanic corrosion.
TF	SIGRAFLEX® TF	Special PTFE Coated Grade for the manufacture of stuffing box packings with reduced friction and leakage; manufactured from flexible graphite foil $\geq 98,0\%$ carbon content, ash content $\leq 2\%$, total chloride content ≤ 25 ppm.
HTX	SIGRAFLEX® P	Flexible graphite foil with outstanding oxidation resistance, used for the manufacture of packing rings to seal valve shafts in various industrial applications; ash content $\leq 1\%$, total chloride content ≤ 20 ppm.

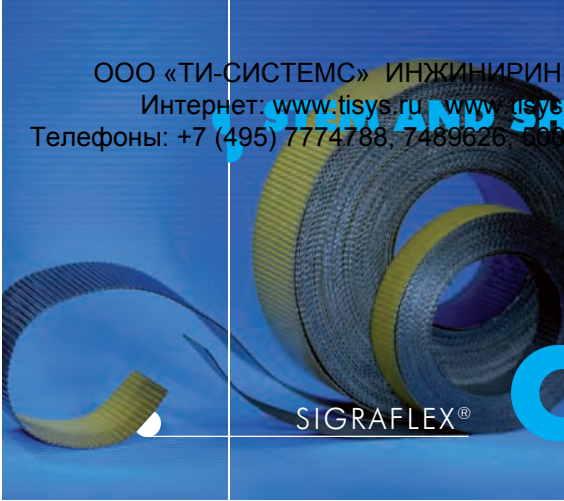

General informations

Effect of temperature on loss of mass by SIGRAFLEX® APX and SIGRAFLEX® P

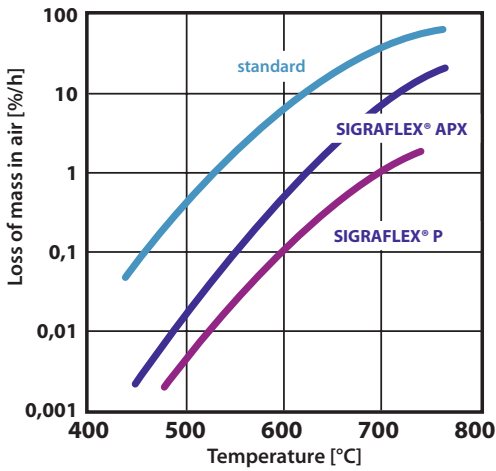

SIGRAFLEX® APX, SIGRAFLEX® P

Proper selection of the sealing material ensures long-lasting and failure-free use of the highest quality fittings. Graphite rings made of SIGRAFLEX® APX and SIGRAFLEX® P foil prolong the working life. Graphite rings of SIGRAFLEX® APX and SIGRAFLEX® P foil demonstrate loss of mass smaller by an order of magnitude than rings of pure graphite.

Recommended density of GRAFMET® rings

Proper selection of density of sealing rings ensures their long-lasting and failure-free operation, no caulking required. Increased density of sealing results in smaller leakage through rings. The higher pressure while fittings operation, the higher density of sealing, i.e. smaller leakage through rings.

Relationship between service pressure and initial GRAFMET® density

PRESSURE MPa	10	16	20	25	40	63
DENSITY g/cm ³	1,3	1,4	1,5	1,6	1,7	1,8

Recommendations regarding structures of stuffing box

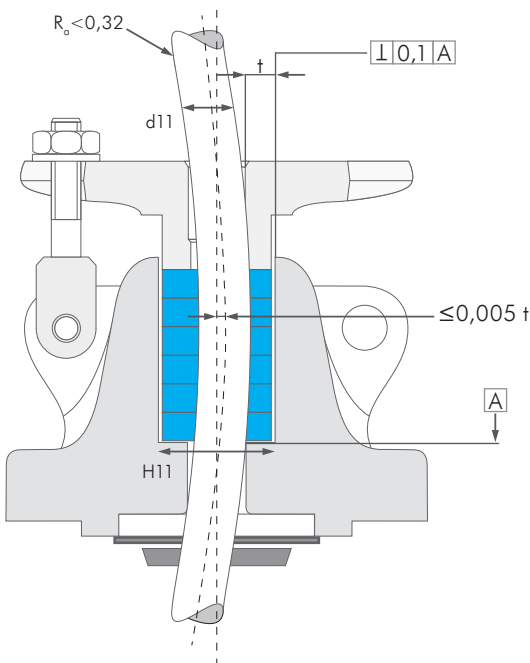

Recommended widths of packing as a function of stem diameters

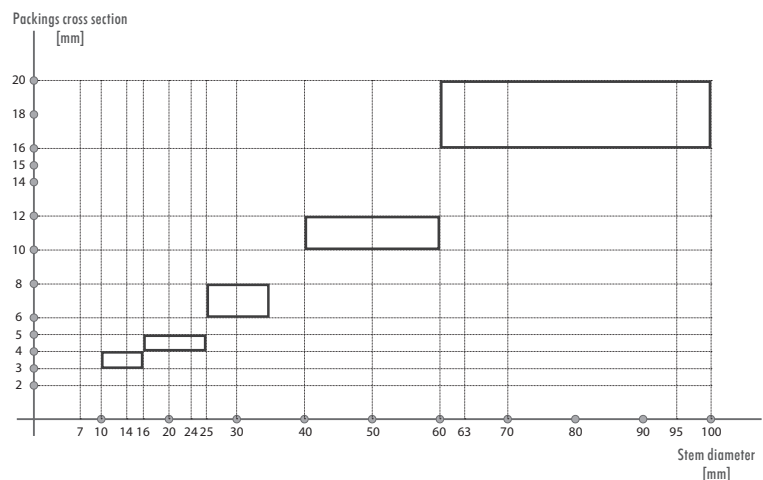



Preformed graphite rings

Code	Sketch	Description
GRAFMET® 950		<p>This is a basic form the rings to seal up stems of fittings are made by moulding a graphite foil up to required density (see the table), usually within 1.3÷1.8 g/cm³ (standard density: 1.4g/cm³). The cross-section of the GRAFMET® 950 ring is usually a square, however a rectangular cross-section is also available. GRAFMET® 950 has a high ratio K of transformation of axial stress forces into radial stress forces (0.8÷0.9, depending on its density). They are made of various types of graphite foil – see the table. As a standard, if no other designation is provided, rings are made of SIGRAFLEX® C foil. When other types of foil are used, it is designated adequately, for instance: GRAFMET® 950 TF, etc. GRAFMET® 950 can be used individually (new fittings with stems of rather small diameters, systems of rather low pressure) or in sets (see: valve stuffing-box sets) as main rings responsible for sealing. It is also a component of special packing sets.</p>
GRAFMET® 950 I		<p>Its construction form has an appearance nearing to GRAFMET® 950, but it is strengthened with an internal reinforcement of 316L grade steel. The reinforcement is designed to improve mechanical extrusion resistance. Usually it is made of SIGRAFLEX® C graphite foil. Its principal application is to work as a closing rings (top or bottom ring) in a sealing packet (e.g. SPETOPAK® WGR 951/950). Its function is to prevent extrusion of the proper sealing material into gaps around a gland and/or in the bottom of a stuffing-box.</p> <p>The GRAFMET® 950 I ring can be used as a distance piece in a long stuffing-box (see: GRAFMET® HD). Also other materials (e.g. nickel foil) can be used as a reinforcement in special products, and the rings can be made of other types of the SIGRAFLEX® foil.</p>

braided packing

pure graphite ring

packing with internal metal reinforcement

other materials

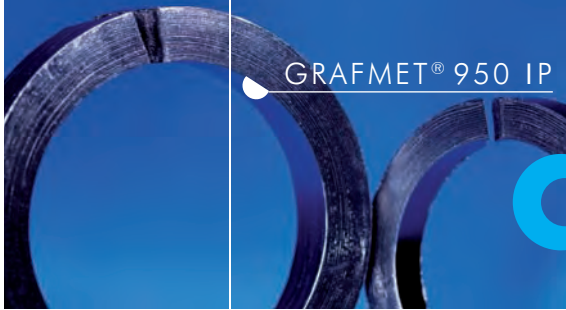

Preformed graphite rings

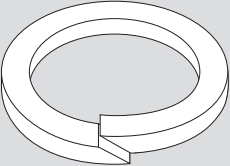
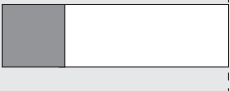
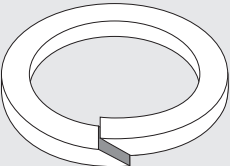
Code	Sketch	Description
GRAFMET® 950 P	 	<p>Rings are designed principally to be used by a final user to seals glands of fittings during repairs. The rings are produced using the same technology as GRAFMET® 950 rings, but their circumferences are obliquely cut to facilitate assembly operations in stuffing-boxes avoiding removal of their drives. Please note such an operation requires rather advanced maintenance skill.</p> <p>While assembling, the cuts in individual rings in the packet must be turned by 90°, 120° or 180°. Setting the cuts in one generating line is inadmissible!</p> <p>The GRAFMET® 950 P rings, having density 1.4g/cm³ as a standard, are made of SIGRAFLEX® C foil. Naturally, they can be made of other types of the foil, however it has to be indicated in the respective designation (e.g. GRAFMET® 950 PN – made of SIGRAFLEX® Z foil, and many others according to the table).</p>
GRAFMET® 950 IP	 	<p>Such rings are used mostly by a maintenance service to protect the proper sealing packet against extrusion, and/or to shorten long dimensioned stuffing-boxes. They are used as guides of stem in bottom area of stuffing-boxes. Their usage is advisable mostly due to their cuts in their circumferences facilitating assembly without removal of a drive.</p> <p>However, such a solution has some practical inconveniences and therefore sealing sets containing more flexible closing rings, made for instance of a SPETOPAK® SGR 880R braided packing, are used more frequently. GRAFMET® 950 IP is normally made of the SIGRAFLEX® C foil having a standard density of graphite 1.4g/cm³. Of course, other densities and/or types of foil are also available, thus the specific requirement should be indicated in the order.</p>



GRAFMET® 950 IPP

Preformed graphite rings

Code	Sketch	Description
GRAFMET® 950 PP		<p>The rings are conformable, in their essence, with descriptions of construction forms of the GRAFMET® 950 and GRAFMET® 950 I respectively. Their differences to the above consist in two cuts in their circumferences facilitating assembly operations. Unlike the rings with one cut, the piece with two cuts is not deformed during assembly. Hence, the ring of even very small diameter and considerable width can be used without risk of damage is sealing functions. Of course, correct installation requires accuracy and compliance to the rule that a cut in every layer is turned by 90° to the other one.</p> <p>Particularly such a construction is required for rings relatively stiff (due to high density) or inserted with a metal foil. In such situations two cuts provide real facility in assembly.</p>
GRAFMET® 950 IPP		<p>GRAFMET® 950 IPP rings are normally made of the SIGRAFLEX® C foil having a standard density of graphite 1.4g/cm³. Other densities and/or types of foil are also available, thus the specific requirement should be indicated in the order.</p>

braided packing

pure graphite ring

packing with internal metal reinforcement

other materials



Preformed graphite rings

Code	Sketch	Description
<p>GRAFMET® 952 HTX (upper ring)</p>		<p>The ring of such a form is designed to protect against squeezing (flowing) of the sealing material (graphite) into gaps existing on place of its application. Another function is to minimize access of oxygen to graphite. The ring can be used individually in static applications as sealing of a cylindrical surfaces, and/or as an upper/lower ring in a packet sealing a stuffing-box. In such a case, forged material of low tacking to the stem material is recommended (see also: WGR 952/950), as for instance nickel.</p> <p>Applying to systems of high pressure, density of graphite is recommended to be selected according to the working pressure (see the table), the standard density of the product is 1.6g/cm³ and the product itself is made of SIGRAFLEX® C foil. In case of power system applications, SIGRAFLEX® P foil is recommended (designation is: GRAFMET® 952 HTX).</p>
<p>GRAFMET® PROFIL#...</p>		<p>The rings GRAFMET® Profil#... with respective description are use in, according to an individual design, machine, fittings, and/or pump construction.</p> <p>Their use is related to simplification of their structures by implementation of special sealing profiles. It allows, for instance, to reduce the number of components, to decrease a joint outline by separation three rooms (areas) with one seal, to reduce void pockets, to facilitate assembly operations. Parameters that can be assorted by SPETECH® while manufacture of GRAFMET® Profil#... profiled rings, are: geometry, density (density distribution), stiffness/hardness, split or not split, etc. Adjustments are made directly with the constructor of the equipment. Sealing of diameters up to 2000mm are available, density from 1.1g/cm³ up to 1.9g/cm³.</p> <p>The above solutions can contain metal pieces pressed in, and can be an integral part of a constructure, and not only a sealing.</p>



SPETOPAK® WGR-TA

Stuffing box sets

Code	Sketch	Description
SPETOPAK® WGR-TA1		<p>The certified sealing set of leak tightness: $3,2 \cdot 10^{-3}$ mbar·l/(s·m) according to VDI 2440 in compliance with requirements of the German Clean Air Act TA-Luft. Tightness is certified for operation in a temperature of equal and above 250°C. The set is made of expanded graphite, hence its high resistance to relaxation. The SPETOPAK® WGR-TA1 sealing set is distinguished by its lowest, of all known products, assembly pressure of 40N/mm². The reinforced closing rings allow operation of the set in highest pressure systems (up to 300bar). When operation in a very high temperature is planned, consultation about the reinforcing material is recommended and use of an unstandard reinforcing material can be required.</p> <p>The set consists of 6 profiled rings, each of them has a different function, therefore the condition for effective operation is to use a complete packet.</p> <p>The effect of highest tightness is achieved due to special profiles of the rings and suitably selected density of respected items of the packet.</p> <p>Intending to achieve required effects of leak tightness, a full packet should be used observing requirements regarding method of assembly (assembly stresses, setting up rings) and condition of the fittings (e.g. roughness of a stem surface).</p>
SPETOPAK® WGR-TA 8515		<p>SPETOPAK® WGR-TA 8515 is a sealing set of tightness in accordance to VDI 2440 ($5,6 \cdot 10^{-5}$ mbar·l/(s·m) as required by the German Clean Air Act TA-Luft for temperatures lower than 250°C. It is made of multi-filament yarn consisting of carbon fiber and PTFE film. It is available both as a cord on a spool and/or complete packet. When a cord is concerned, it must be taken into account that achievement of required degree of leak tightness in compliance with the TA-Luft regulation requires the ring has to be prepared according to description contained in the certification report.</p> <p>Also in this case, intending to achieve required effects of leak tightness, a full packet should be used observing requirements regarding method of assembly (assembly stresses, setting up rings) and condition of the fittings (e.g. roughness of a stem surface).</p> <p>Please note that SPETECH others sets of TA-Luft packing sets are soon to be certified (e.g. SPETOPAK® WGR-TA 8535 and SPETOPAK WGR-TA 8530). For most updated list of 'Clean Air Act' complied packings, as well as packings sets acc. to API of Fire Safety Tests please contact SPETECH.</p>
SPETOPAK® WGR-TA 8535		
SPETOPAK® WGR-TA 8530		

braided packing

pure graphite ring

packing with internal metal reinforcement

other materials

СПЕТОПАК® WGR 952/950 HTX



Stuffing box sets

Code	Sketch	Description
SPETOПАК® WGR 952/950 HTX		<p>The SPETOПАК® WGR 952/950 HTX sealing set consists of two types of rings: closing rings (on top and bottom) reinforced with steel members, and the appropriate sealing rings placed in a middle of the packet height. The rings are made of the SIGRAFLEX® P foil providing the highest, as achieved today, resistance to oxidation.</p> <p>Due to the treatment, i.e. implementation of a special construction form and the special material, SIGRAFLEX® P, the packet can be applied to systems of highest pressure (depending on the structure of the sealing joint: 630bar) and temperature up to 700°C.</p> <p>If the temperature is to be higher than 450°C, you are kindly requested to contact us to select the best metal material.</p>
SPETOПАК® WGR 900 RR/950		<p>The SPETOПАК® WGR 900 RR/950 sealing set is designed to be used in high-pressure fittings, in systems of up to 300 bar pressure and 650°C temperature. The packet consists of closing rings made of SPETOПАК® 900 RR packing with special braided Inconel® reinforcement and graphite of increased resistance to oxidation owing to special inhibitors. The Grafmet® 950 sealing rings can also be made of graphite of increased oxidation resistance of the foil: Sigraflex® E, Sigraflex® APX, or Sigraflex® P. In such a case there are products designated: WGR 900 RR/950 E, WGR 900 RR/950 APX, and/or WGR 900 RR/950 HTX respectively.</p> <p>Advantage of the packet is its capacity to be installed on fittings without removal of a drive (in such a case WGR 900 RR/900 P has to be used).</p>
SPETOПАК® WGR 950 I/950		<p>SPETOПАК® WGR 950 I/950 sealing is a packet designed to be used, first of all, by fittings manufacturers. It is highly economical solution regarding its delivery cost, but must be installed on fittings without the drive. However, this restriction can be avoided using GRAFMET® WGR/950 IP/950 P. It is designed to be used on fittings in systems of up to 300bar and/or 550°C (then the WGR 950 I/950 HTX product is recommended). The packet can be made of various types of graphite foil, that provides capacity to be used in a very wide range of applications. Main applications are: cut-off valves for power industry, petrochemistry, refineries, heat engineering.</p> <p>Application to industrial purposes requires proper selection of packet density that has an effect on leak tightness (the higher density the better tightness) and/or on facility in assembly (the lower density the easier assembly).</p>

СПЕТОПАК® WGR 880 R/950



Stuffing box sets

Code	Sketch	Description
СПЕТОПАК® WGR 880 R/950		The СПЕТОПАК® WGR 880 R/950 set is used most widely as a repair packet (also as a WGR 880 R/950 P product) in power industry, petrochemistry, refineries, and/or heat engineering. The graphitized fibre, that the closing rings are made of (reinforced additionally with Inconel® wire), is highly suitable when installed on fittings with wide gaps in stuffing boxes and/or on stems that have lost their nominal roughness, because the graphitized fibre has very good mechanical properties making squeezing of the product into gaps practically impossible. Inconel® is used to provide durable mechanical qualities of the reinforcement in very high temperature, and to make sticking of the product to a stem surface practically impossible. Maximal parameters of the product operation depend, of course, on a structure and technical condition of fittings the product is applied to. If there are new fittings, parameters of 300bar and/or 550°C are quite possible.
СПЕТОПАК® WGR 554		The СПЕТОПАК® WGR 554 sealing packet is designed for fittings of various applications and/or metering plunger pumps. The only restriction is the maximal temperature 280°C. The packet is made of braided packing of PTFE yarn, modified according to the purpose. The product in its basic form (designation S) is impregnated with fine-grained teflon without any lubricant, having the best chemical and/or ageing resistance. In case of more dynamic applications, where addition of lubricant is allowed, impregnation contains paraffin oil (designation WGR 554). The packet in this version has a high wear resistance. It can be also applied to fittings in oxygen systems (designation WGR 554 OX) with pressure up to 150bar.

braided packing

pure graphite ring

packing with internal metal reinforcement

other materials

СПЕТОПАК® SPT 554



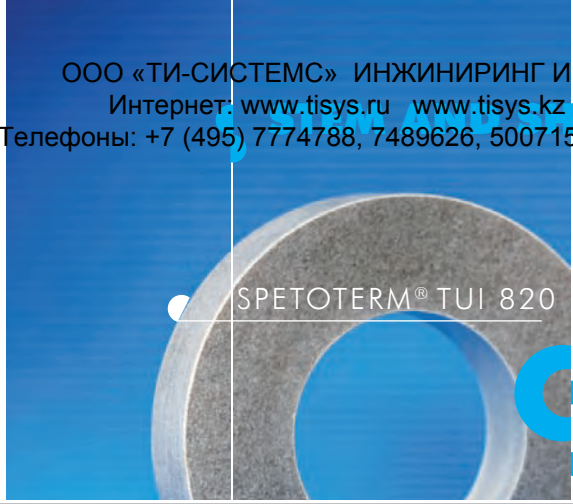

Stuffing box sets

Code	Sketch	Description
<p>СПЕТОПАК® WGR 554/160</p>		<p>The СПЕТОПАК® WGR 554/160 packet is designed to be used in plunger pumps, principally pumps batching various chemicals. The product is used mostly because of its high stiffness and resistance to squeezing. Moreover, interlayers of filled PTFE has high thermal conductivity. Depending on operating conditions, chemical compatibility with the medium to be sealed, and/or durability expectation, stiffening rings can be made either of synthetic carbon (WGR 554/carbon) or PEEK material (WGR 554/PEEK), or highly-compacted rings of expanded graphite can be applied to a respective purpose (WGR 554/950HD). In some specific cases, the stiffening rings are made of brass and/or bronze.</p>
<p>СПЕТОПАК® WGR SPECIAL#...</p>		<p>The СПЕТОПАК® WGR SPECIAL#... sealing packets can be designed according to expected critical loads. Selection of a suitable form, and material and/or dynamic structural features can provide optimal resistance to abrasion/hydraulic impacts/temperature changes, leak-proofness, minimal friction, etc.</p> <p>There are various criteria of optimization depending on planned application (cut-off valves, control valves, size of a stem, plunger pump, etc.).</p> <p>СПЕТОПАК® WGR SPECIAL#... might be equipped also in additional special components like: anti-extrusive rings, V-shape rings, O-rings, GRAFMET® rings, injectable compounds, machined metal rings, etc.,</p>



SPETOTERM® TUI 820

Distance bush

Code	Sketch	Description
SPETOTERM® TUI 820		<p>The SPETOTERM® TUI 820 distance rings are made of mica composite material of admissible operating temperature up to 650°C.</p> <p>The material is almost absolutely chemically resistant, having good sliding properties (low friction factor, no sticking to steel), and high ageing resistance.</p> <p>SPETOTERM® TUI 820 rings are used as distance rings in long stuffing-boxes, sometimes being also used as guides for stems. They can be used as closing rings (under gland) in special sets, as well.</p> <p>Due to high temperature resistance, the material is implemented to sealing engineering. Rings are produced according to respective requirements, to customized requirement only.</p>
GRAFMET® 950 HD		<p>The GRAFMET® 950 HD rings are made of expanded graphite, compacted to 1,9g/cm³ density. They can be made also with internal reinforcement of a steel foil 0.1 mm, ANSI 316.</p> <p>The rings are used as distance rings installed at bottoms of stuffing-boxes, and/or as a component of WGR Special high-pressure sets.</p> <p>Their advantage is almost complete chemical resistance and/or resistance to highest temperatures used in power engineering. The rings as guiding-distance rings at bottoms of stuffing boxes can be applied to a temperature up to 650°C. They are particularly usable when shortening stuffing-boxes of old fittings, constructed to be used with asbestos packing previously.</p>

 braided packing

 pure graphite ring

 packing with internal metal reinforcement

 other materials





Braided packings for valves

Code	Picture	Description																				
SPETOPAK® SGR® 804 W		<p>The hybrid packing made from the graphited synthetic yarn and flexible graphite, the inonel reinforced synthetic yarn braided in the corners prevents the packing from being extruded and reduces the abrasion of the elastic graphite; the SPETOPAK® SGR® 804 W packing is an alternative to the sealing sets, as both sealing and closing functions are performed by each separate ring of the packing; this style is preferred by the maintenance departments in refineries, petrochemical and power plants.</p> <table border="1"> <thead> <tr> <th></th> <th>И</th> <th>И</th> <th>И</th> </tr> </thead> <tbody> <tr> <td>t °C</td> <td colspan="3">-100 ÷ +550</td> </tr> <tr> <td>P. atm</td> <td>250</td> <td>-</td> <td>-</td> </tr> <tr> <td>V m/s</td> <td>2</td> <td>-</td> <td>-</td> </tr> <tr> <td>pH</td> <td colspan="3">0 ÷ 14</td> </tr> </tbody> </table>		И	И	И	t °C	-100 ÷ +550			P. atm	250	-	-	V m/s	2	-	-	pH	0 ÷ 14		
	И	И	И																			
t °C	-100 ÷ +550																					
P. atm	250	-	-																			
V m/s	2	-	-																			
pH	0 ÷ 14																					
SPETOPAK® SGR® 880		<p>It is made of graphitized fibre synthetic yarn, containing high-quality lubricating and anti-adhesion mediums; impregnated right through while braided, and additionally, while drying and calibrating, surface-impregnated with a graphite layer. SPETOPAK® SGR® 880 packing is resistant to temperature, good heat abstraction, to be applied individually or in WGR® stuffing-box sets. Appreciated in industry, used in both traditional and nuclear power engineering. Applied to both hot water and steam systems; either in high-speed heavy duty pumps.</p> <table border="1"> <thead> <tr> <th></th> <th>И</th> <th>И</th> <th>И</th> </tr> </thead> <tbody> <tr> <td>t °C</td> <td colspan="3">-100 ÷ +550</td> </tr> <tr> <td>P. atm</td> <td>200</td> <td>100</td> <td>26</td> </tr> <tr> <td>V m/s</td> <td>1</td> <td>1.5</td> <td>26</td> </tr> <tr> <td>pH</td> <td colspan="3">0 ÷ 14</td> </tr> </tbody> </table>		И	И	И	t °C	-100 ÷ +550			P. atm	200	100	26	V m/s	1	1.5	26	pH	0 ÷ 14		
	И	И	И																			
t °C	-100 ÷ +550																					
P. atm	200	100	26																			
V m/s	1	1.5	26																			
pH	0 ÷ 14																					
SPETOPAK® SGR® 880 R		<p>The packing made from graphited synthetic yarn designed for the highest parameters encountered in the conventional power plants, refineries and power plants; ensures the smooth operation of the spindle and prevents the corrosion of the gland; SPETOPAK® SGR® 880 R does not show ageing processes; has corrosion inhibitor; reinforced with an inonel wire; applied both as the only ring in the gland and in the sealing sets as the anti-extrusion rings for flexible graphite.</p> <table border="1"> <thead> <tr> <th></th> <th>И</th> <th>И</th> <th>И</th> </tr> </thead> <tbody> <tr> <td>t °C</td> <td colspan="3">-100 ÷ +550</td> </tr> <tr> <td>P. atm</td> <td>300</td> <td>-</td> <td>-</td> </tr> <tr> <td>V m/s</td> <td>1</td> <td>-</td> <td>-</td> </tr> <tr> <td>pH</td> <td colspan="3">0 ÷ 14</td> </tr> </tbody> </table>		И	И	И	t °C	-100 ÷ +550			P. atm	300	-	-	V m/s	1	-	-	pH	0 ÷ 14		
	И	И	И																			
t °C	-100 ÷ +550																					
P. atm	300	-	-																			
V m/s	1	-	-																			
pH	0 ÷ 14																					

СПЕТОРАК® SGF® 772

Braided packings for valves

Code	Picture	Description																				
СПЕТОРАК® SGR® 800 R		<p>Made of elastic graphite yarn, every fibre is reinforced with inconel wire braid, type SGR® 800 R. The SGR® 800 type without inconel reinforcement, designed to pump applications. Reinforced heavy duty packing of high mechanical properties; resistant to high temperature, good heat abstraction, easy to shaping. Designed to be used in refineries, petrochemical industry, power engineering; to be used individually or as closing packing in WGR® high-temperature sets.</p> <table border="1"> <thead> <tr> <th></th> <th></th> <th></th> <th></th> </tr> </thead> <tbody> <tr> <td>t °C</td> <td colspan="3">-100 ÷ +550</td> </tr> <tr> <td>P. atm</td> <td>200</td> <td>-</td> <td>-</td> </tr> <tr> <td>V m/s</td> <td>2</td> <td>-</td> <td>-</td> </tr> <tr> <td>pH</td> <td colspan="3">0 ÷ 14</td> </tr> </tbody> </table>					t °C	-100 ÷ +550			P. atm	200	-	-	V m/s	2	-	-	pH	0 ÷ 14		
t °C	-100 ÷ +550																					
P. atm	200	-	-																			
V m/s	2	-	-																			
pH	0 ÷ 14																					
СПЕТОРАК® SGR® 900 RR		<p>Made of highest-quality expanded graphite yarn, every fibre is reinforced with a net of an inconel wire. It contains inhibitors of corrosion and oxidizing. Due to application of a fibre, reinforced with inconel braid, the packing demonstrates high mechanical properties and/or resistance to be blown out. Being impregnated, while braided, with high-temperature mediums containing corrosion and oxidizing inhibitors, it demonstrates good slide, anticorrosion, and anti-adhesion heavy-duty properties. It is designed to be used in the chemical industry, petrochemical industry, heat engineering, and/or power generation heavy duty installations, even in supercritical systems, to be applied individually or as closing packing in WGR® 900 RR sets.</p> <table border="1"> <thead> <tr> <th></th> <th></th> <th></th> <th></th> </tr> </thead> <tbody> <tr> <td>t °C</td> <td colspan="3">-100 ÷ +650</td> </tr> <tr> <td>P. atm</td> <td>300</td> <td>-</td> <td>-</td> </tr> <tr> <td>V m/s</td> <td>1</td> <td>-</td> <td>-</td> </tr> <tr> <td>pH</td> <td colspan="3">0 ÷ 14</td> </tr> </tbody> </table>					t °C	-100 ÷ +650			P. atm	300	-	-	V m/s	1	-	-	pH	0 ÷ 14		
t °C	-100 ÷ +650																					
P. atm	300	-	-																			
V m/s	1	-	-																			
pH	0 ÷ 14																					
СПЕТОРАК® SPT® 554 S		<p>The packing braided from PTFE yarn of the chemical resistance and physiological properties which allow it to be applied for practically all media encountered in the industry, except for molten alkali metal and some fluorinated compounds; applied in the valves in the chemical industry for the most aggressive media also in the high pressure; special styles: SPT® 554 OX for the contact with oxygen – the packing without any additional agents used for technological reasons, SPT® 560 K with aramid reinforcement in the corners – to be applied in high pressure plunger pumps.</p> <table border="1"> <thead> <tr> <th></th> <th></th> <th></th> <th></th> </tr> </thead> <tbody> <tr> <td>t °C</td> <td colspan="3">-100 ÷ +280</td> </tr> <tr> <td>P. atm</td> <td>150</td> <td>150</td> <td>15</td> </tr> <tr> <td>V m/s</td> <td>1</td> <td>2</td> <td>4</td> </tr> <tr> <td>pH</td> <td colspan="3">0 ÷ 14</td> </tr> </tbody> </table>					t °C	-100 ÷ +280			P. atm	150	150	15	V m/s	1	2	4	pH	0 ÷ 14		
t °C	-100 ÷ +280																					
P. atm	150	150	15																			
V m/s	1	2	4																			
pH	0 ÷ 14																					



Ball valves seats

Code	Sketch	Description
SSA 10		<p>The SSA 10 seat is a basic form of seats applied mostly to ball-type small-dimension fittings designed for cold-media and/or moderate-pressure applications.</p> <p>They are made mostly of pure PTFE (pure PTFE provides the smallest possible friction factor and good chemical resistance), or of PTFE filled with carbon or graphite. Metal/graphite and/or impregnated synthetic graphite compositions are not so popular.</p> <p>Though it is a very cheap structure, applications to high pressure and/or temperature systems are somehow restricted regarding resistance and/or creep properties. In case PTFE is considered, secondary sealing (in the body) is not required, because the seat can satisfy this need.</p>
SSA 11		<p>The SSA 11 seats without housings can be made as multi-component PTFE structures. Such a design can be fire-safe, practically with no modifications of the structure. This is a multi-component seat of principally PTFE and graphite. In regular applications, the sealing is of a PTFE-metal type. In case of fire (PTFE is burnt off) sealing of the ball is transformed in a metal-graphite composition.</p> <p>Since the profile of SSA 11 has practically the same dimensions as a SSA 10 profile, adjustment of the internal sealing structure to fire hazard requirements is restrained to modification of the seat only.</p>
SSA 20		<p>Designing ball-type fittings suitable to meet high technical requirements, abrasive media, and/or big diameters, their ball seats have to be tear reinforced and erosion protected. One of possible solutions is installation of a sealing component between external ring (tearing) and internal ring (erosion). Such a structure can be applied to seats of PTFE and/or PTFE composite material, as well as to sealing components of carbon and/or graphite. Depending on material of a seat and/or the shape of a sealing ring back, secondary sealing can be avoided. Such a structure allows for using floating seats.</p>

metal

PTFE

reinforcement graphite

other materials



Ball valves seats

Code	Sketch	Description
SSA 30		<p>The SSA 30 seats of fittings, trilaterally enclosed in steel housings, have the highest strength properties and/or erosion resistance. It can freely move inside the body, according to the structure concept.</p> <p>Such a structure requires to install secondary packing between the body and seat. The structure can be used as a fire-resisting product with a seat of PTFE. In case of fire, upon PTFE is burnt off, the steel housing operates as a sealing.</p> <p>Either PTFE composite materials or carbon/graphite materials can be used, as well as other suitable materials on a customer requirement, as for instance polymer materials.</p>
SSA 40		<p>The SSA 40 seat is a popular type for ball-type fittings, because secondary sealing can be avoided, and they can be used in great axial-movement applications.</p> <p>The structure is designed for seats with sealing components made of PTFE or PTFE compositions.</p> <p>The metal component protects against erosion of the disk spring. The outside 'soft' cylindrical surface of the seat provides leak-proofness, even when moving. The steel ring can be used also as an emergency fire-resistant sealing. For such an application, it should be machined.</p>
SSA 50		<p>Intending to prevent failure of ball cocks having seats made of brittle materials, e.g. made of synthetic carbon or graphite, shrinkable steel mountings are used. Between the mounting and the seat, there can be inserted glue (caulking), and inside the mounting structure a room for secondary sealing can be constructed.</p>
SSA 60		<p>Seats of a SSA 50 profile are applied mostly to ball-type taps with balls supported on trunnions (trunnion ball valves). The seat has to be held down to the ball by pressure thrust, because the ball itself is fixed.</p> <p>There are a number of various seat structures having capacity to move under pressure, and their geometry is designed to reduce thrust of the seat against the ball when the valve is opened, hence life of the valve is extended.</p> <p>Regarding the SSA 50 structure, the basic part of the sealing is the steel component, whilst the sealing piece itself is a pad of a relatively small section.</p>

Butterfly seals

Code	Sketch	Description
SPETORING® RDE		<p>The solid metal or metal-graphite sealing for the double and triple offset butterfly valves. Available for valves with seat surface integral with the body and sealing ring in the disc assembly or sealing ring in the body and seat surface in the disc.</p> <p>Dimensions, materials upon request.</p> <p>The double offset design (RDE) is made in dimensions up to 3000mm. The design of a dimension above 800 mm is recommended to be reinforced with rivets. The triple offset design (RTE) is made in dimensions up to 1200mm. Faying surface roughness Ra=1.6. Standard materials used to manufacture SPETORING® RDE and/or SPETORING® RTE are austenitic steel (304, 316L, 321 etc.), duplex, C-276, and others to respective order. The graphite material is Sigraflex® as shown in the Table...</p> <p>SPETORING® RDE and/or SPETORING® RTE are designed to particular types of fittings, and usually are constructed according to drawings of their manufacturer. In some specific cases, SPETECH® can reconstruct the throttle gland basing on dimensions of the body/casing (it refers mostly to models withdrawn from production). Regarding a 'sandwich' design, the number of steel interlayers is usually 3 or 4, however in case of large diameters the number can be even 12. Thickness of graphite is usually between 0.3÷1mm.</p> <p>Options:</p> <ul style="list-style-type: none"> – solid metal sealing ring in the disc assembly – laminated metal-graphite metal sealing ring in the disc assembly – solid metal sealing ring in the body assembly – laminated metal-graphite metal sealing ring in the body assembly
SPETORING® RTE		<p>Options:</p> <ul style="list-style-type: none"> – solid metal sealing ring in the disc assembly – laminated metal-graphite metal sealing ring in the disc assembly – solid metal sealing ring in the body assembly – laminated metal-graphite metal sealing ring in the body assembly



metal



PTFE



reinforcement graphite



other materials



Kammprofile, spiral wound gaskets, RTJ

Code	Sketch	Description
DRYFLEX®, SPETOMET® MWK		Third generation of a kammprofile gasket. The DryFlex® gasket was designed as a high quality industrial gasket, combining the advantages of soft-material gaskets and metal gaskets. Very high elastic recovery, blow-out resistance and the surface pressure. The gasket is in compliance with the tightness criteria of VDI 2200 and can be regarded as a high-grade sealing system for the purposes of TA-LUFT. Also available standard profiles SPETOMET® MWK – see SPETECH STATIC GASKETS
SPETOSPIR®		Spiral Wound Gaskets (SWG) for covers of fittings are made according to customer specifications, specifying the following features: – thickness of a gland: 2.5mm; 3.2mm; 4.5mm – outline (contour): round, elliptic, oval, rectangular (see Drg.) – stiffness: standard or 'Low stress' – material combination: standard metal materials for production of SWG products, see Table... – mostly used shapes in valves: S, SWZ The glands can be installed on faying surfaces: Flat Faces (SZ, SWZ), Raised Faces (SW, SWZ), Tongue and Groove (SI), Male/Female (S, SW), also in a joint with so called Multi-channel transmission.
SPETORING® RTJ		Generally, the RTJ glands are made according to the dimensional standards as API 6B, ASME 16.20, EN 12 560. The basic shapes are rings of an octagonal section (SPETORING® RTJ-R) or oval section (SPETORING® RTJ-OR). They are applied mostly to oil and gas systems, and to medium- and high-pressure power installations. SPETORING® RTJ is a sealing resistant, almost completely, to blowing out, having a double line of sealing that augments is operational safeness. The gland should be made of a material more soft than the material of flanges (flanges must have respective seats). Most popular options of the material are shown in the Table ... SPETORING® RTJ can be offered in other material options and/or unstandard dimensions. Customized options with silver/chromium/zinc coating are also available.

Outlines of SPETOMET® MWK® and SPETOSPIR® for fittings

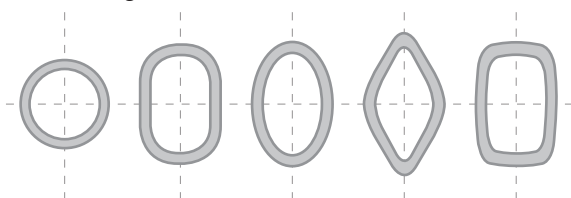

Typical materials used in SPETORING Sealing*

Material	Admissible Hardness	
	Brinell	Rockwell „B”
Soft iron	90	56
Low-carbon steel	120	68
Steel: Cr - 4-6%; Mo - 0,5%	130	72
Steel 410	170	86
Steel 316	160	83
Steel 347	160	83

* – other materials for request

GRAFMET®

Self-sealing graphite rings

Code	Sketch	Description
GRAFMET® 960		<p>GRAFMET® 960 is a basic form of rings to seal up bonnets / covers of valves. GRAFMET® 960 rings are made by moulding a graphite foil up to required density (standard density here is 1.6g/cm³). It is used in fittings and/or apparatus as so called self-sealing. When GRAFMET® 960 is applied, the gaps between the body and cover, the cover and pressure ring, the pressure ring and body, should be max. 0.7mm; whereas the gaps are larger and/or contact stress is $\delta > 100 \text{ N/mm}^2$, GRAFMET® 962 is recommended. At present, GRAFMET® 960 is reinforced with foil of stainless steel. GRAFMET® 962, also of a trapezoidal geometry, has an external reinforcement in a form of steel noses preventing its squeezing out even there are larger gaps $> 0,7\text{mm}$ and/or great contact stress $> 100\text{N/mm}^2$; an additional function of steel noses is to prevent erosion and oxidation processes. Steel noses for large diameters and/or wide gaps can be made by fully machining, their designation is GRAFMET® 962 M. They are mostly applied to closing covers. Having a rectangular section, the designation is GRAFMET® 970, and with steel noses GRAFMET® 972.</p> <p>The complex profile of the GRAFMET® 968 sealing is recommended to be used in self-caulking joints of small diameters ($< 80\text{mm}$) and/or relatively low pressure ($< 16 \text{ bar}$).</p> <p>Regarding fittings of larger gaps, a GRAFMET® 960 R traditional ring with a steel spiral reinforcement of ring corners is recommended. The function of spiral reinforcement is the same as of steel noses applied to GRAFMET® 962 and/or GRAFMET® 962 M rings.</p>
GRAFMET® 962		
GRAFMET® 962 M		
GRAFMET® 960 R		
GRAFMET® 970		
GRAFMET® 972		
GRAFMET® 968		
SPECIAL SELF-ADJUSTED SET TRANSFLEX®		<p>The GRAFMET® 970 rings are available in a special TRANSFLEX® set containing metal sectional rings of variable dimensions enabling compensation of clearance, even large ones of unpredicted dimensions, on existing high-temperature great-flow fittings and/or apparatus and heat exchangers, under self-caulking covers. A soft component can be offered as a pre-formed graphite ring, e.g.: TRANSFLEX® 960/970, or woven packing, e.g.: TRANSFLEX® 960/880.</p> <p>Structures for rectangular stuffing-boxes are also available. In such a case, soft sealing component remains unchanged whereas two expanding rings are installed on the box bottom. This is the Transflex® 970/970 product.</p>

Standard metal materials for production*: Dryflex®, SPETOMET® MWK, and SPETOSPIR®

ANSI	DIN	PN
316L	1.4404	0H17N14M2T
321	1.4541	1H18N9T
Alloy C-276	Alloy C-276	Alloy C-276

* – other materials for request

Standard soft materials for production*: Dryflex®, SPETOMET® MWK and SPETOSPIR®

Graphite SIGRAFLEX® C>98%	FG-C	550°C
Graphite with oxidation inhibitor SIGRAFLEX® APX	FG-APX	650°C
PTFE	PTFE	280°C
Ekspanded PTFE	ePTFE	280°C
Silver Ag>99%	AG	650°C
Mica	TUI 810	750°C

* – other materials for request



SPETECH® LL

Code	Sketch	Description
<p>PACKING CUTTER 45</p>		<p>The tool designed to precise cutting of stuffing-box rings made of spliced cord. The tool provides proper cutting of sealing ends, so while putting them together the cord can be properly joined. Regarding sealing for fittings, recommended angle of cutting is 45°.</p>
<p>EXTRACTOR BOX</p>		<p>The set of tools for fitters and/or maintenance service. The set contains tools to remove worn packing, matched to various sizes of sealing, as well as flexible connectors with replaceable ends, extractors.</p>
<p>SPETECH® LL</p>		<p>SPETECH manufactures and delivers systems of pull and control of wear degree of packing, so called the Live-Loading (SPETECH® LL) system. They are used to compensate and identify packing wear, for compensation of relaxation of both stuffing-box sealing and screws, and owing to a tension indicator built in the device they facilitate assembly operations. SPETECH® implements LL systems also into the existing fittings that have not been constructed with intention to use LL systems. Intending to solve such a case, SPETECH® has worked up and implemented disk springs of a special type, having holes for stuffing-box screws.</p> <p>Generally, SPETECH® LL systems can be used as centralized systems (on a mandrel) or as uncentral systems (on screws). Materials of springs allow to use the systems in a temperature up to 650°C.</p>

СПЕТОПАК® SGE 760 K

Conversion table of packing kilograms (weight) into linear meters (length)

Packing		[g/cm ³]	4	5	6	7	8	10	12	14	16	18	20	22	25
SPT 554S	[m/kg]	1,65	35	22	16	13	9,4	5,6	3,9	2,9	2,2	1,7	1,4	1,2	0,9
SGR 900 RR	[m/kg]	1,35	52	34	23	17	13	8,3	5,8	4,3	3,3	2,6	2,1	1,7	1,3
SGR 880	[m/kg]	1,35	51	33	22	16	11	8,1	5,6	4,1	3	2,3	1,9	1,4	1,1
SGR 880R	[m/kg]	1,3	52	34	23	17	13	8,3	5,8	4,3	3,3	2,6	2,1	1,7	1,3
SGR 804W	[m/kg]	1,3	60	36	24	19	17,4	8,7	5,9	4,4	3,4	2,8	2,2	1,8	1,4
SGR 800	[m/kg]	1,2	51,9	35	23,3	17,3	13,3	8,4	5,5	4,28	3,5	2,59	2,3	1,8	1,4
SPT 554OX	[m/kg]	1,65	35	22	16	13	9,4	5,6	3,9	2,9	2,2	1,7	1,4	1,2	0,9
SGR 800R	[m/kg]	1,3	60	36	24	19	17,4	8,7	5,9	4,4	3,4	2,8	2,2	1,8	1,4
SGR 800	[m/kg]	1,25	52	34	23	17	13	8,3	5,8	4,3	3,3	2,6	2,1	1,7	1,3

Please note:

- above table is only estimation
- packing are sold in kilograms as standard

Standard package of SPETOПАК® glands



cross section [mm]	package [kg]	0,5	1	2,5	5
3–6		X	X	X	
7–15			X	X	X
16–25				X	X

СПЕТОПАК® SGR 887

© Fluid Sealing Association
 European Sealing Association

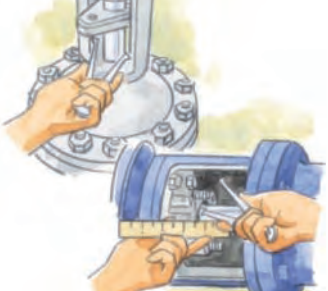

Pump & Valve Packing Installation Procedures

<p>TOOLS REQUIRED</p>		<p>Specific tools are required for removal of the old packing and installation of the new packing, as well as tensioning of the fasteners. In addition, always use standard safety equipment and follow good safety practices. Acquire the following equipment prior to installation:</p> <ul style="list-style-type: none"> - Calibrated packing ring cutter and torque wrench or spanner - Flashlight - Helmet - Inside & outside calipers - Lubricant for fasteners - Mirror - Packing extractor - Packing knife - Safety goggles - Steel rule - Tamping tool - Vernier dial gauge - Other plant-specified equipment
<p>CLEAN AND EXAMINE</p>		<ul style="list-style-type: none"> • Loosen gland follower nuts slowly and lift follower to release any trapped pressure under packing set. • Remove all old packing and thoroughly clean shaft/stem and stuffing box area following plant-specified procedures. • Examine the shaft/stem for corrosion, nicks, scoring or excessive wear. • Examine other components for burrs, cracks, or wear that could reduce packing life. • Check stuffing box for excessive clearances and shaft/stem for eccentricity. • Replace any components found defective. If in doubt, seek advice. • Inspect old packing as part of failure analysis for clues to cause of premature packing failure.
<p>MEASURE AND RECORD</p>		<ul style="list-style-type: none"> • Document the shaft or stem diameter, stuffing box bore and depth, and, when using lantern rings, distance of port to bottom of stuffing box.
<p>SELECT PACKING</p>		<ul style="list-style-type: none"> • Assure packing is as specified by packing manufacturer and/or plant engineering department to match service conditions. • Calculate packing cross section and number of rings needed from recorded measurements. • Examine packing to be sure it is free from defects. • Refer to any special installation instructions from packing manufacturer. • Ensure cleanliness of equipment and packing before proceeding

СПЕТОПАК® SGR 887

© Fluid Sealing Association
European Sealing Association



Pump & Valve Packing Installation Procedures

PREPARE RINGS



Braided

- Wind packing around properly sized mandrel, or use calibrated packing ring cutter.
- Cut packing cleanly, either butt (square) or skive (diagonal), per instructions from packing manufacturer or plant engineering department.
- Cut one ring at a time, and, using shaft or stem, check for proper sizing.

Die formed/molded

- Assure that rings are sized precisely to shaft or stem.
- Cut rings, when necessary for installation, according to instructions from packing manufacturer or plant engineering department.

INSTALL PACKING

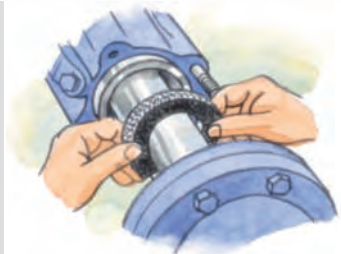

- Carefully install one ring of packing at a time.
- Twist each ring over shaft/stem.
- Ensure each ring is seated fully in stuffing box prior to installing next ring.
- Stagger joints of subsequent rings a minimum of 90 degrees.
- After last ring is installed, draw gland up evenly until nuts are finger-tight.
- Check lantern ring, if used, for correct positioning relative to port.
- Make sure shaft/stem turns freely.

ADJUST PACKING (VALVES)



- Consult packing manufacturer and/or plant engineering department for guidance on torque specifications or percent of compression.
- Tighten gland nuts in multiple steps:

Step 1 – Torque gland bolts to approximately 30% of full torque or appropriate compression percentage.

Step 2 – Cycle the valve a number of times and apply full torque while valve is in closed stroke position.

Step 3 – Repeat Step 2 three or four times.

RETIGHTENING AND REPLACEMENT



Caution: Consult your packing manufacturer and/or plant engineering department for guidance and recommendations on retightening. It is advisable to check gland adjustment after a few hours of operation. Tighten as necessary. Packing must be replaced when gland can not be adjusted further.

SPETECH®, DryFlex®, SPETORING®, SPETOCAF®, SPETOFLON®, SPETOMET®, SPETOSPIR®, SPETOTERM®, GRAFMET®, SPETOPAK®, TRANSFLEX®, MWK® are registered trademarks of SPETECH. Gore-GFO®, Gore® – registered trademarks of W.L.Gore. Sigraflex® – registered trademark of SGL Carbon Group. Data presented above is based on the best available knowledge but does not imply liability on Spetech's part. The proper service of the installation depends on many factors which need to be evaluated on case to case basis. SPETECH® reserves the right to update and introduce changes in accordance with the best knowledge and technology available in the area described in this catalogue.